

SENSOR	Type
KT38PM8	PNP
KT38P3M	PNP
KT58PM8	PNP
KT58P3M	PNP
KT38NM8	NPN
KT38N3M	NPN
KT58NM8	NPN
KT58N3M	NPN

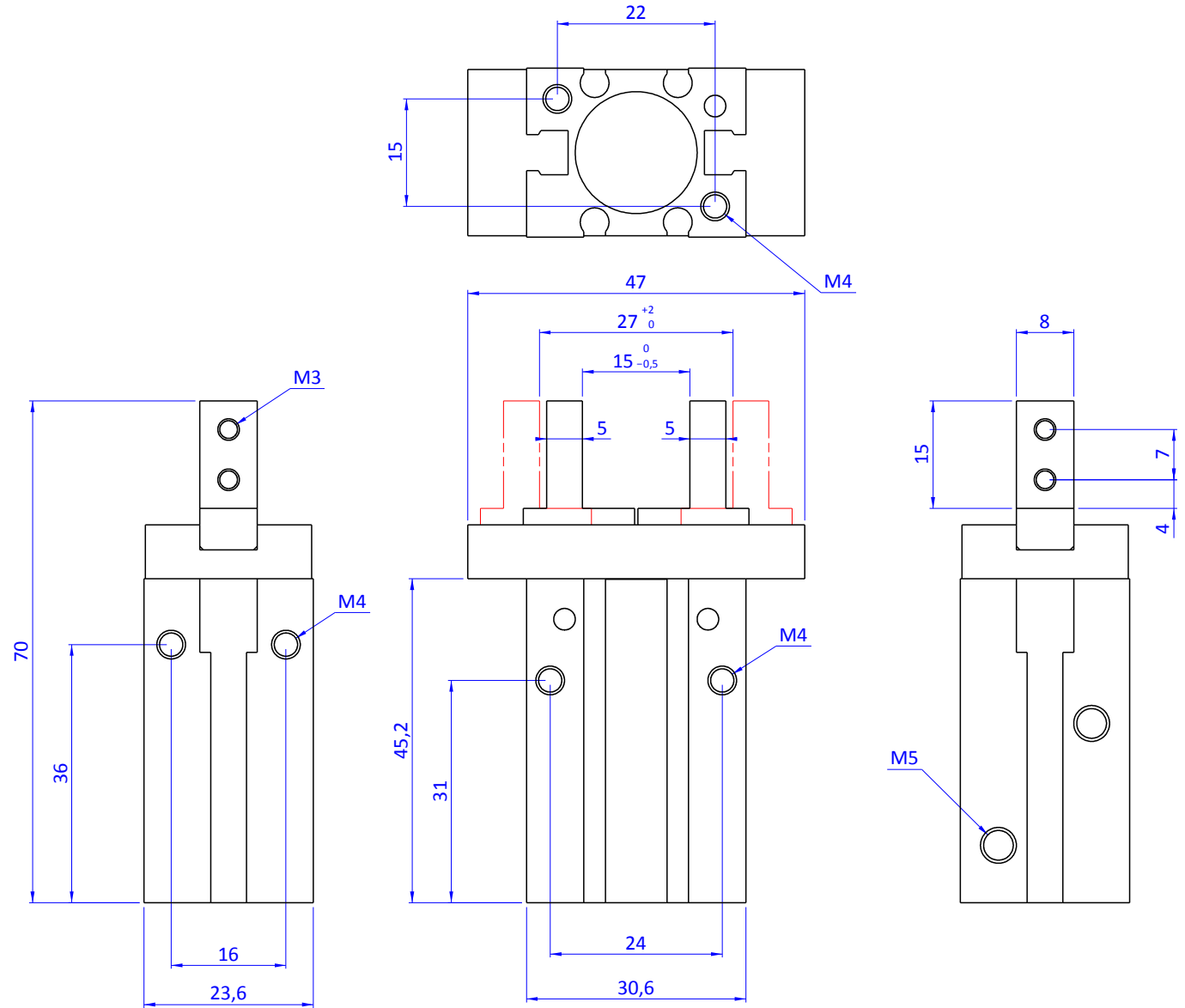
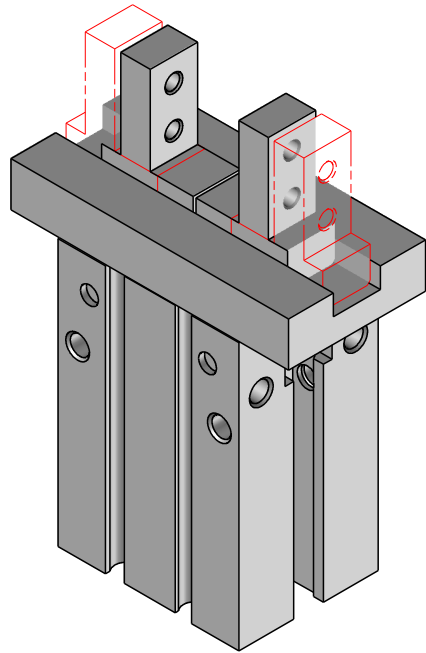

"CA.09.05.010.L" is realized by other manufacturers.

FPS-Automation is just seller.

Format A3

UNI 936-76

 FPS FPSERVICES AUTOMATION		DESIGNED FROM		REVIEW
		FPS Automation		A
GENERAL TOLERANCE		DATE	WEIGHT	
UNI - ISO 2768		27/06/2019	0,135Kg	
CLASSE F		CODE		
		CA.09.05.010.L		CA.09.05.010.L

THE PROPERTY OF THE DRAWING IS ESTABLISHED BY LAW. IT IS FORBIDDEN TO PRODUCE OR SHOW IT TO THIRD PARTY, WITHOUT A WRITTEN AGREEMENT.